

The Church of
ST. WILLIAM THE ABBOT
A Roman Catholic Church
2740 Lakewood Allenwood Road
Howell, NJ

We, the parish family of St. William the Abbot, a welcoming Catholic community, led by the Holy Spirit, are called to proclaim, and to witness to, the Good News of Salvation, so that we may grow together, among all generations, and advance the Kingdom of God, in our love and service of God and neighbor.

**MASS SCHEDULE
WEEKENDS**

Saturday: 4:00PM (Vigil)
Sunday: 8:00, 10:15 & 11:45AM

WEEKDAYS

Monday & Tuesday: 9:00AM
Wednesday: 9:00AM & 7:00PM
Thursday, Friday & Saturday: 9:00AM

HOLY DAYS OF OBLIGATION

As announced in the bulletin.

CONFESSIONS

Saturday after the 9:00AM Mass, and 3:00 to 4:00PM. Half hour before each weekend Mass, and Wednesday at 6:00PM.

ROSARY

The Rosary is recited weekdays and Saturdays after the 9:00AM Mass with the Exposition of the Blessed Sacrament.

Parish email: stwilliam@optonline.net
Website: stwilliamtheabbot.com
Phone: 732-840-3535



Rev. Thomas Maher, Pastor
Rev. James Redstone, In Memoriam
Rev. Lewis Papera, Weekend Assistant
Rev. Michael Vona, Weekend Assistant
Deacon Michael Abatemarco, Pastoral Associate
Deacon George A. Prevosti
Deacon Kevin Smith

PARISH OFFICE HOURS

Monday—Friday, 9:30AM—1:30PM
(Closed on Holy Days & Legal Holidays)

ANOINTING OF THE SICK

This sacrament is given for those facing serious illness or surgery, and for those of advanced years. If you or a family member plan to enter the hospital, please see Fr. Tom following Mass if you would like to receive this sacrament. In case of emergency, please call the parish office.



December 28, 2025 Feast of the Holy Family

What is an active parishioner?

An active parishioner is a person who participates in the life of the Church. This means to follow the teachings of Jesus Christ and share in Christ's role as priest, prophet and King. We are called to lead others to faith by our good example, through loving service to others, and offering our prayers, works and activities to God.

- An active parishioner is a person who has received or is preparing to receive the sacraments of Baptism and Confirmation.
- An active parishioner is a person who attends Mass regularly at St. William the Abbot and actively supports the sacramental programs for Penance, Eucharist and Confirmation. Parents who want a Catholic Faith Formation & Education for their children will see to it that their family attends Mass faithfully EVERY Sunday.
- An active parishioner gives of themselves by donating TIME, TALENT and TREASURE to the ministries of the parish and or to the volunteer organizations that support the parish. We are to share in the responsibilities that keep our Parish alive in a vibrant way.
- An active parishioner is a good financial steward of the church. As a parishioner, it is important to understand that giving financially to support the parish is a vital and key component to active parishioner status.

Why you need to be an active parishioner?

Parishioners seeking to be godparents or sponsors for the Sacraments of Baptism and Confirmation, or those wishing to be joined in Holy Matrimony must first be verified as "active members" of the parish.

An active member:

- 1) Is properly registered with the parish
- 2) Faithfully attends Mass on Sundays and Holy Days of Obligation
- 3) Participates in parish activities/ministries whenever possible.
- 4) Consistently uses the parish envelope system or the electronic giving program to support the parish.



The Sanctuary Lamp is lit in memory of Mildred Gilbert r/b Peter Gilbert Family.



Weekly Collection for December 14, 2025

Number of registered families. . .	1209
Number of envelopes. . .	.81
Envelope contributions. . .	\$3,154.00
Loose contributions. . .	\$504.00
Priests' Retirement Fund. . .	\$540.00
Flowers. . .	\$665.00
Christmas. . .	\$965.00
WeShare. . .	\$2,751.00

Total. . . \$8,579.00

Thank you! We are so grateful to all those who financially sacrifice each week to support our parish and its ministries! We would especially like to thank all those who faithfully use their weekly parish contribution envelopes and those who give online through WeShare.

Pray

The Family that prays together stays together! (Fr. Payton)

"Heavenly Father, we ask You to bless our family. Open our hearts to receive Your love. May our home be another Nazareth, so that our family may be a place where Your peace and love abides. Open our eyes to recognize the gift and beauty of life, so that we may find joy in Your presence among us. Grant us pure hearts seeking holiness, generous hearts full of Your love, merciful hearts ready to forgive and tender hearts full of kindness. May our family be a sanctuary of life and love, a beacon of hope drawing others to your Son, Jesus Christ. Amen. Jesus, Mary, and Joseph, Holy Family of Nazareth, pray for us."

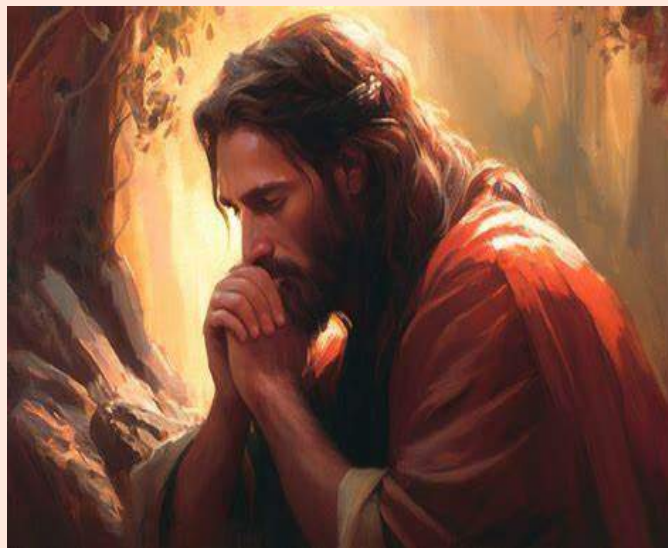

Weekly MASS Intentions

©PPCC

"It is a holy and wholesome thing to pray for the living and the dead." II Mac. 12:46

Saturday, December 27 St. John the Apostle

9:00—Special intention for Ian Miller
r/b Miller Family
4:00—Stella Capriotti
r/b Capriotti Family

Sunday, December 28 The Holy Family

8:00—Sandra Campos
r/b Ron Campos
10:15—People of the Parish
11:45—Carol Tutone
r/b Deacon Mike & Pat

Monday, December 29 St. Thomas Becket, Bishop

9:00—Special intention for John & Ann Pangaro
r/b Pangaro Family

Tuesday, December 30

9:00—Ellen D. Smith
r/b Joe Mannion

Wednesday, December 31 / (Vigil) Solemnity of Mary, the Holy Mother of God

9:00—Patricia O'Rourke
r/b Pangaro Family
*4:00—Fr. Vic Magdarog
r/b St. William the Abbot Parish Family
*7:00—People of the Parish

Thursday, January 1 Solemnity of Mary the Holy Mother of God / New Year's Day A Holy Day of Obligation

*10:00—Krista Lukenbill
r/b Lenardo Family

Friday, January 2 First Friday / Sts. Basil the Great & Gregory Nazianzen

9:00—De Santis Family
r/b Beyer Family

Saturday, January 3 First Saturday / The Most Holy Name of Jesus

9:00—Andrew Howard
r/b M/M Venuto
4:00—Mary Powers
r/b Joe & Sharon Acconzo

Sunday, January 4 The Epiphany of the Lord

8:00—People of the Parish
10:15—Joseph Macaluso
r/b Linda & Joe Macaluso
11:45—William Baunagh
r/b Deacon Kevin & Diane

The power of prayer!

PRAY FOR HEALING

©PPCC

Please bring health, healing, and hope to those who are sick in our community, especially: Jonathon Capriotti, Emily Capriotti, Matthew Cerritelli, John Sproat, Jr., June Daquaiust, Eileen Bertola, Michael Untisz, Joseph Untisz, Wayne Farmer, Barbara Maloney, Natasha Sanchez, Richard Policastro, Erin Mackintosh, Gene Sacco, Johnny Daley, Richard Romano, Kerry O'Connor, Ethel Lowe, Nicola Schirripa, Mary Ann Carissimo, Debbie Palmer, Gina Furci, Dr. Fiore, Lisa Brooks, Daniel Bivona, Alana Parisi, Nicholas Asterino, Nicholas Serzan, Michael Thompson, Anthony, Donna Calamia & Grace Santisi. We also ask you Lord, to watch over all those with incurable autoimmune diseases and for all those who are afflicted with cancer, MS, CF, Lou Gehrig's disease, for those who suffer from Alzheimer disease, dementia, addictions, and their families. **God of all consolation, give life and health to our sisters and brothers for whom we pray in your Holy Name. Amen.**



Please keep in your prayers those serving in our military. Send in names of friends or family members you would like us to pray for:

Oryah Hametz Hokzler—Army
Vincent Moran—Marines
Hunter Freedline--Army
John & Emma Carlucci—Air Force
Anthony Morsillo—Marines
Kathryn McEnaney—Coast Guard
Mitchell McEnaney—Coast Guard
Katie Austin Underhill—Army
Jeremy Ramos—Air Force
Eddie Roszkowski—Navy
Aaron MacDonald—Marine
Max Culbertson—Navy
Eric Hertel—Navy
Lauren Millerbernd—Marines
Darlene Pabon—Army



Pray to your Guardian Angel everyday:
Angel of God, my guardian dear, to whom God's love commits me here. Ever this day, be at my side, to light and guard, to rule and guide.



Reading I: Sirach 3: 2-6, 12-14 The author teaches a filial respect for one's parents, and then the text shifts to the concrete help that children should extend to them "in old age and in times of illness, loneliness, or distress."

Reading II: Colossians 3: 12-21, or 3: 12-17 Paul gives his pastoral instruction on family life. He challenges every household to be transformed with "the peace of Christ." This peace is far more than the absence of hostility. It is a deep-rooted sense of connection to Christ through love and obedience to His way of understanding each other.

The Gospel: Matthew 2: 13-15, 19-23 God works within the family structures. For example, St. Joseph is instructed by the angel because he is the head of the Holy Family, and the one most responsible for their well-being. We should also note his obedience in a very difficult time for the Family.



**Our Holiday Mass Schedule
'2025-'2026**

New Year's Eve, Wednesday, December 31, 2025

***Vigil Solemnity of Mary, Holy Mother of God**
9:00am *4:00pm *7:00pm

New Year's Day, Thursday, January 1, 2026

***Solemnity of Mary, Holy Mother of God**
*10:00AM

***Fulfills Holy Day of Obligation for this Solemnity**

Ways to remember or commemorate an event at St. William the Abbot

Commemorative Bricks: This is an ideal way to commemorate a graduation, wedding, special family celebration, or to acknowledge a loved one. To order a brick, which will be placed in the garden near Mary, contact the parish office. The cost is \$100 for 8x8 brick and \$75 for a 4x8 brick.

Bequests

St. William is a tax-exempt non-profit Organization and gratefully accepts donations from last will and testament and/or stock to assist our parish. For more information on how to have your wishes known, please talk to your personal banking representative. May God Bless you for your generosity!

Sanctuary Lamp

The Sanctuary Lamp can be lit in honor of or in memory of a loved one for one week. It is announced in the bulletin and before all the Saturday/Sunday Masses. The donation is \$25.

Flowers for Jesus

Flowers for Jesus is a bouquet of flowers that will be bought in honor or memory of a loved one. They will be placed at the Altar for the weekend Masses. It will be announced in the bulletin and at each Mass. The donation is \$50.



Celebrating 40 Years of the St. William the Abbot Parish

Our Anniversary Committee is now diligently planning special events to celebrate our 40th Anniversary throughout the year. ALL are welcome to join the committee and help with the planning. Below is a list of members of the committee so far; if you would like to join it or get involved, please email one of the members below and they will reach out to you.

- Tricia Berwick: tberwick@live.com
- Diane Smith: foodiedcs@aol.com
- Pete Gilbert: pete2516@optimum.net
- Deacon Kevin: kmsmith9@aol.com
- Sal Ciardiello: salmaypink@hotmail.com
- Mike Eadicicco: 195mead2@aol.com
- Lorrie Gratton: lorrie915@aol.com

Thank you to all who have donated to our Christmas Flowers. These are the people for whom we have been asked to pray:

Sime Hidalgo, Leonor Hidalgo, Emilio Tapnio, Geronima Tapnio, M/M P. Ozzo & Children, M/M M. Dragotta, Alva & Randall Kelly, Beatrice Anderson, Duncan & Zipporah Wallen, Verona Anderson, Crudelle Family, O'Connor Family, DiPaul Family, Ceferino Costales, Roberto Mendoza, Patricia Mendoza, Jankowski Family, Alfred DeDominicis, Helen DeDominicis, Vincent Scalsese, Kevin Corr, Loretta Petri, Lucy Battaglia, Peter C. Petri, Domenic Battaglia, John & Mary Morsillo, Cosmo & Carmela Silvestri, Janice Ciardiello, Jean Ciardiello, James Ciardiello, Mike Duggan, Mary Powers, Bess Stillwell, Mary Powers, Bess Stillwell, Marge Vultee, Anne Maruk, Brian O'Reilly, James Morecraft, Ana Guillermo, Rosa Sofia Guillermo, Jose J. Guillermo, Antonia Guillermo, Belinda Jackson, The Jones & Eckert Families, John & Eleanor Corti, Tom Nebus, Ben & Hatti Nebus, Butala Family, Connie D/Amico, Susan Gondevas, Mary Venezia, Mircovich Families, Seymour Families, Agnes guiff, Parise & Cannavale Families, Sue Iacangelo, Elizabeth Capitan, Theresa Capitan, Margaret Kristofer, Robert Pignatore, Veronica Malecki, Edward Malecki, Danny Bacsik, John Szynal, Augustyniak Family, Szynal Family, Philip & Rivalta Valenza, John & Nimfa Shomers, Erica Dahlkemper Baughman, Robert & Laura Camp, John & Mildred Gilbert, Sarah Gilbert, Michael Gilbert, Dennis Gilbert, James & Roberta Dahlkemper, Jack Culbertson, Goldie Gomes, M/M Leo Bizzarro, M/M John Ruane, Linguard Family, Edward Truax, Patrick Truax, M/M Louis Angelucci II, M/M Joseph Smoyak, Ernest Smoyak, Louis Angelucci, Sr., Helen Zmijewski, Joan P. Frammosa, Joseph & Anna Spoto, Rose & Steve Marino, Lucille Wood, Henry & Evelyne Filipek, Laurentino & Nidia Vieira, Jensen & Maloney Family, Haberjan Family, Philemena Passarella, Michelle & Alan Tatusko, Lucienne Haberman, M/M Kenneth Mayer, Kitty Rucci, Thomas Gebhardt, Kevin McCormick, Ann Munyer, George Munyer, Joan Moroney, Thomas Moroney, Saverio Camporeale, Maria Camporeale, Peter Cerreta, Sr., Denise Bartone, Flora DiGiallonardo, Frank Giovina, Nicholas Castagna, Joseph & Marie Selvaggi, Elaine Nilsen, Patsy & Marie Franzese, Catherine & John Acconzo, Edward & Patrick Truax, Durnin Family, Kerrigan Family, Rotberg Family, Nick Angiulo, Fran Angiulo, Mary Golio, Tony Golio, John & Elizabeth Duffy, Eugene & Alice Cisek, Martinez Family, Joseph Caccese, Kayo & Jennie Adams, Biagio & Grace Amato, Isabella Family, M/M Gene Kelly, Sally Idrael, Fr. Charles & Norma Moore, Jill Galante, Mandola Jr. Family, Cranwell & Nunziata Families, Gladys Echevarria, Jose A. Torres, Carmen L. Santiago, Herimo Santiago, Lorec Brown, Jill Gergurich, M/M Michael Kollar, Ann Sanguetti, Spampinato Family, Mata Family, Russo Family, Mackintosh Family, Mildred Casazza, Titus Casazza, Anna Ghigliotti, Louise Ghigliotti, John McAleavey Sr., Joan McAleavey, Ruth Joan McAleavey, Ruth Steele, John Matthews, Holmes Family, Bars Family, Manzella Family, Maselli Family, Bachurek Family, Martino Family, Lenardo Family, Lenardo Family Friends, Trusso Family, Gaul Family, Gray Family, Christopher Lysstianto, Joseph Marano, Jean Marano, Kay & Harry Redmond, Mary & Warren Dougherty, Robert Dougherty, Robert Dougherty, Richard Grasso, Murray Family, William Clark, McTague Family, De Felice Family, Morin Family, Marie DeSantis, John DeSantis, Nancy Ciano, Josephine Rizzo, Mary Thompson, Linda Romano, M/M Joseph Modica, M/M Anthony Somma, Antoinette Modica, Anthony Modica, Thomas A. DiMattina, Kevin Rizzo, Elsie Harkins, Catherine Brunetti, Mary & Patrick Cleary, James Gratton, Debbie Gratton, Gerald F. Caci, Joyce M. Caci, Lois DeRosa, Vincent Portera, Pete & Theresa Schmidt, Lorraine & Ronald Masarik, Ralph Pizzano, Tony Del Guercio, Christine Pizzano, Ann Del Guercio, Ernest Russo, Frances Crispino, Anne Russo, Emanuel Puglisi, Mary Puglisi, Harold Turner, Thersa Turner, John & Virginia Ball, Fr. Jim Redstone, Vincent M. Maher Jr., Rosemary Maher, Michael Maher

A New Years Prayer

Another Year is dawning
 With the chance to start anew
 May you be kinder, wiser
 In all you say and do
 Not so caught up in selfish gain
 That you would fail to see
 The things in life that mean the most
 Cost not a fancy fee
 The warm kind word that you can give
 The outstretched hand to help
 The prayers you pray for those in need
 More precious these than wealth
 You know not what may be ahead
 Of laughter or of tears
 You only need to know each day
 That our Lord is walking near
 You should be thankful for
 this brand new year
 As now you humbly pray
 Your hand secure in our dear Lord
 Each step along the way.
 Amen

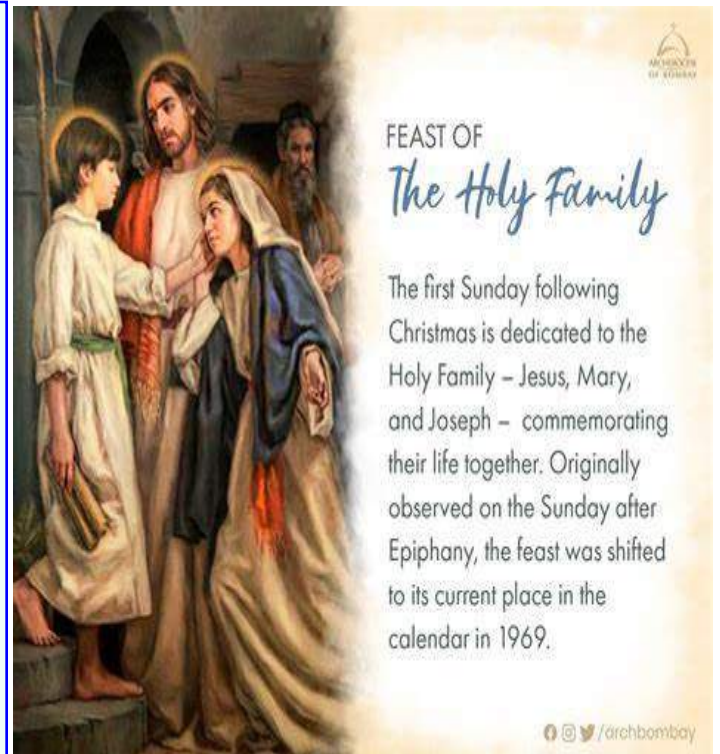

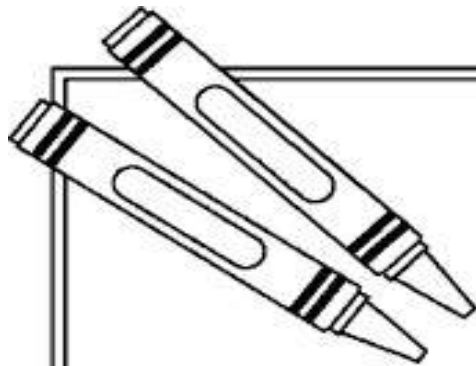

Just for KIDS

Luke 2:1-20

In Luke 2:1-20, we read the familiar story of Jesus' birth. The scrambled words and names in the list below are a part of that story. Unscramble them and circle them in the puzzle.

You will find them → ↓ ↗ ← ↑ ↘

- | | | |
|---------------|----------------|-----------------|
| eaCrsa _____ | aMyr _____ | zaNhtare _____ |
| gnamre _____ | opesJh _____ | uutuAsgs _____ |
| laiGele _____ | auedJ _____ | rephsehds _____ |
| nso _____ | csenus _____ | teeBhhelm _____ |
| hritb _____ | ilfeds _____ | enagl _____ |
| adfari _____ | david _____ | tginh _____ |
| oylgr _____ | oyj _____ | robn _____ |
| athre _____ | isbotfrn _____ | ecrdee _____ |
| eecpa _____ | nin _____ | |



B C A E S A R M E A R T H
 D E C R E E E Y R U A G B
 F N T R B I R T H G F A O
 I S Y H S O N N I U R L R
 R U O Y L E G N A S A I N
 S S J G P E A C E T I L M
 T J O S E P H C J U D E A
 B S D R E H P E H S A E N
 O M A R Y H R I M S V T G
 R F I E L D S T H G I N E
 N A Z A R E T H M A D S R



There will be 14 uncircled letters. Write them in order from top to bottom on the lines. They will spell a special message to you.

In-Home Senior Care

We provide all kinds of assistance, from personal care to light housekeeping. We keep seniors in their own homes and enable them to live independently.



732-530-3636

697 Broad Street #202
Shrewsbury, NJ 07702

fully licensed and insured

www.comfortkeepers.com/centraljersey

*Serving St. William the Abbot
Parish Since 2001*

**Welcome
to Our Church!**



Quail Creek PHARMACY

OPEN EVERY DAY

2 Ramtown-Greenville Rd, Howell Township, NJ

785-9711 • Fax 785-1543

MONA SALAMA, RAOUF SALAMA - PHARMACISTS

PERSONALIZED SERVICE • GIFTS • GREETING CARDS

ASK **#WHATS
MYNAME** 
in remembrance of *Samantha Josephson*

**BEFORE YOU GET
IN A RIDE SHARE**

SAMI

STOP | ASK
MATCH | INFORM

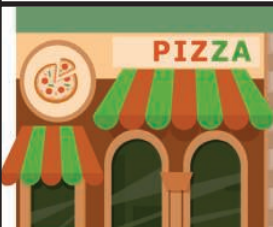

**BUILD YOUR
COMMUNITY**

*- Shop Local -
- Shop Small -*

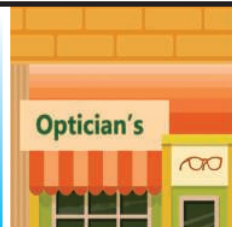

**PLEASE PATRONIZE THE ADVERTISERS
WHO MAKE THIS BULLETIN POSSIBLE!**

**CENTRAL
JERSEY
POOLS** 68
SPAS & MORE



YOUR SUMMER STARTS HERE-DIVE INTO SAVINGS!

ABOVE GROUND • SEMI IN-GROUND
AND IN-GROUND POOLS • HOT TUBS • SWIM SPAS
SAUNAS • CHEMICALS • POOL PARTS
TOYS • SERVICE & MUCH MORE!

**RECEIVE A
\$250 GIFT CARD
WITH THE PURCHASE
OF A HOT TUB, SWIM
SPA, ABOVE GROUND,
SEMI-IN-GROUND
POOL, OR SAUNA**

Scan For Tranquility



HIC LIC#13VH01191400
**RT. 9 NORTH
FREEHOLD, NJ**
centraljerseypools.com
732-462-5005



American Red Cross

Someone Needs You!

VOLUNTEER
and make a difference.

Join today:

redcross.org/Volunteer



INCREASE YOUR VISIBILITY IN THE COMMUNITY

Place Your Ad Here
to Support Our Parish!

**CONTACT ME
Judy McNea**

jmcnee@jppc.net
(203) 856-9085



O'Brien
FUNERAL HOME

Kevin C. O'Brien, Manager - NJ Lic. No. 4805
www.obrienfuneralhome.com
 505 Burnt Tavern Road • Brick, NJ 08724
 732-899-8600
 2028 Highway 35 • Wall Twp., NJ 07719
 732-449-6900
 Family Owned-Family First-Family Operated

PEDIATRIC AFFILIATES PA
www.pediaff.com

Infants, Children & Adolescent Medicine
 Robert A. Shanik, M.D., F.A.A.P.
 Ira Haimowitz, D.O., F.A.A.P.
 Casino 9 • 1001 Rt. 9 N. • Howell, NJ 07731
732-905-9166

Family Owned and Operated Since 1987 **FREE INSPECTION**
 Licensed & Insured



RIGHTWAY WATERPROOFING CO.

BASEMENT WATERPROOFING
 MOLD REMEDIATION
 FOUNDATION REPAIR



732-308-9988



www.RightwayWaterproofing.com

catholicmatch®
New Jersey

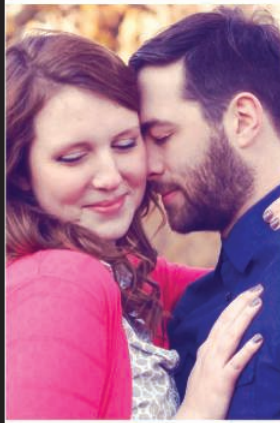

CatholicMatch.com/dateNJ

BoldAge
PACE

A program that helps older adults live a meaningful, independent life at home with grace and dignity.

Medical, Activities Center, Rides to Doctors, Help at Home and Much more.



Scan Here More info

(855) 801-2653

Serving Ocean, Monmouth and parts of Burlington county

SUPPORT
Local
BUSINESS

MALLORY'S ARMY®
Foundation

United Together In The Fight Against Bullying...
 Don't Just Teach Kindness...
BE KINDNESS!

www.MallorysArmy.com
 (973) 440-8657
info@mallorysarmy.org

It's easy to join our mailing list!
 Just send your email address by text message: Text **MALLORYSARMY** to 22828 to get started.

Message and data rates may apply.

KW WEST MONMOUTH
KELLERWILLIAMS REALTY

Proud Parishioner of St. William the Abbot



@ Freehold

Michell Strully
REALTOR® Associate

o: 732-523-4777 | c: 732-915-3142
mstrully@gmail.com
www.mstrully.kw.com

Each office is independently owned and operated.

ROOFING CHIMNEYS MASONRY • GUTTERS DECK REPAIR

We Find & Fix Leaks!



ROYAL PRO CONSTRUCTION

\$1100 OFF

Any New Roof Replacement

20% OFF

Any Roof, Chimney, Gutter, Masonry Repair & SENIORS

check out the latest offerings by your bulletin sponsors by downloading our free app



Family Owned/Operated
 Lic. #13VH0934200
 Bonded & Insured
 20+ Years

732-589-9967

Serving All of New Jersey